

.100"(2.54mm) pitch FFC/FPC Housing Connectors CHS

HF2548B Series

- * Poles: 2~26
- * Material: NYLON66 UL94V-0 ,BLACK
- * Suitable TF2548T series terminal
- * Mates with CW2543X-XX series wafer

Specifications

- * Current rating: 2.A AC, DC
- * Voltage rating: 250V AC, DC
- * Temperature range: -25°C~+85°C
- * Insulation resistance: 1,000MΩ min.
- * Withstand voltage: 800V AC/minute

inches
mm

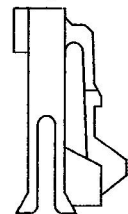
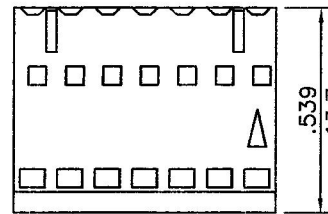
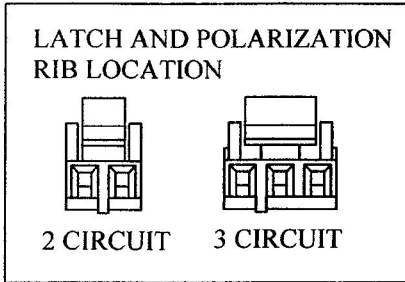
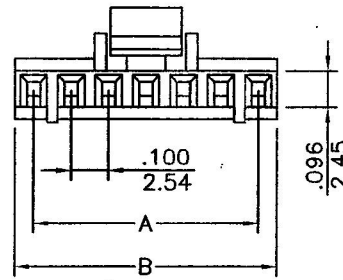

CKTS	PART NO.	DIM. "A"	DIM. "B"	CKTS	PART NO.	DIM. "A"	DIM. "B"
2	HF2548B-02	0.100(2.54)	0.205(5.2)	14	HF2548B-14	1.300(33.02)	1.409(35.8)
3	HF2548B-03	0.200(5.08)	0.307(7.8)	15	HF2548B-15	1.400(35.54)	1.508(38.3)
4	HF2548B-04	0.300(7.62)	0.406(10.3)	16	HF2548B-16	1.500(38.10)	1.610(40.9)
5	HF2548B-05	0.400(10.16)	0.508(12.9)	17	HF2548B-17	1.600(40.64)	1.709(43.4)
6	HF2548B-06	0.500(12.70)	0.606(15.4)	18	HF2548B-18	1.700(43.18)	1.811(46.0)
7	HF2548B-07	0.600(15.24)	0.709(18.0)	19	HF2548B-19	1.800(45.72)	1.909(48.5)
8	HF2548B-08	0.700(17.78)	0.807(20.5)	20	HF2548B-20	1.900(48.26)	2.012(51.1)
9	HF2548B-09	0.800(20.32)	0.909(23.1)	21	HF2548B-21	2.000(50.80)	2.110(53.6)
10	HF2548B-10	0.900(22.86)	1.008(25.6)	22	HF2548B-22	2.100(53.34)	2.213(56.2)
11	HF2548B-11	1.000(25.40)	1.106(28.1)	23	HF2548B-23	2.200(55.88)	2.311(58.7)
12	HF2548B-12	1.100(27.94)	1.209(30.7)	24	HF2548B-24	2.300(58.42)	2.409(61.2)
13	HF2548B-13	1.200(30.48)	1.307(33.2)	25	HF2548B-25	2.400(60.96)	2.512(63.8)

.100"(2.54mm) pitch FFC/FPC crimp terminal

TF2548T Series

- * Material: Phos bronze
- * Finished: Tin-plated
- * Used in HF2548-XX series housings
- * Q'TY: 15,000pcs/reel

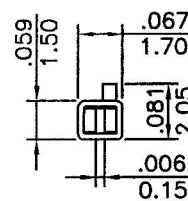

inches
mm

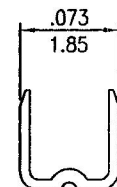
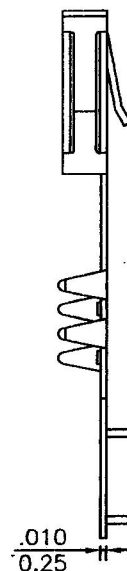
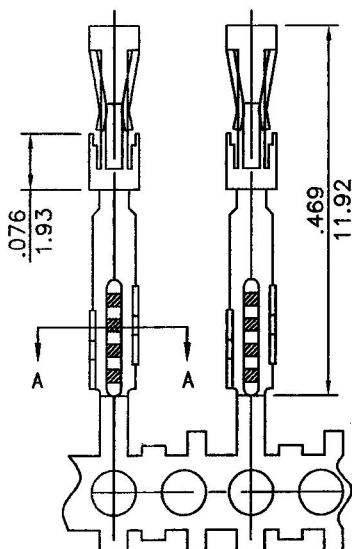

A-A SECTION