

.156"(3.96mm) pitch Wire to Board Connectors



CH393 Series

- * Poles:2-20
- * Material:NYLON 66 UL94V-2
- * Suitable CT393T series terminal
- * Mates with CW393 series Header

Specifications

- * Current rating: 5A AC, DC
- * Voltage rating: 250V AC, DC
- * Temperature range: -25°C~+120°C
- * Insulation resistance: 1,000MΩ min.
- * Withstand voltage: 1,500V AC/minute

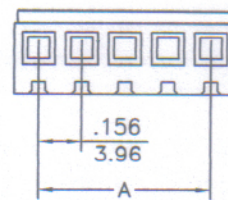

inches
mm

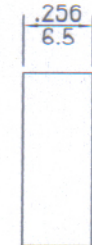
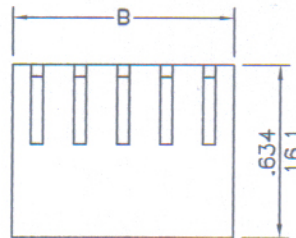

CIRCUITS	PART NO.	DIMENSION in.(mm)		CIRCUITS	PART NO.	DIMENSION in.(mm)	
		A	B			A	B
2	CH393-02	0.156(3.96)	0.339(8.62)	12	CH393-12	1.715(43.56)	1.898(48.22)
3	CH393-03	0.312(7.92)	0.495(12.58)	13	CH393-13	1.871(47.52)	2.054(52.18)
4	CH393-04	0.468(11.88)	0.651(16.54)	14	CH393-14	2.027(51.48)	2.210(56.14)
5	CH393-05	0.624(15.84)	0.807(20.50)	15	CH393-15	2.183(55.44)	2.366(60.10)
6	CH393-06	0.780(19.80)	0.963(24.46)	16	CH393-16	2.339(59.40)	2.522(64.06)
7	CH393-07	0.935(23.76)	1.119(28.42)	17	CH393-17	2.494(63.36)	2.678(68.02)
8	CH393-08	1.091(27.72)	1.275(32.38)	18	CH393-18	2.650(67.32)	2.834(71.98)
9	CH393-09	1.247(31.68)	1.431(36.34)	19	CH393-19	2.806(71.28)	2.990(75.94)
10	CH393-10	1.403(35.64)	1.587(40.30)	20	CH393-20	2.962(75.24)	3.146(79.90)
11	CH393-11	1.559(39.60)	1.743(44.26)				

.156"(3.96mm) pitch crimp terminal

CT393T Series

- * Material:Brass
- * Finished:Tin-plated
- * Used in CH393, CH392 series housings
- * Wire range:AWG#18~#26
- * Insulation O.D.:2.50mm(max)
- * Thickness:0.25mm
- * Q'TY:6,000pcs/reel

P/N : CK393
Polarizing Plug
PA66 UL94V-2

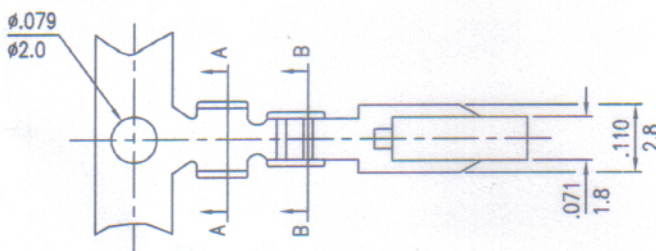
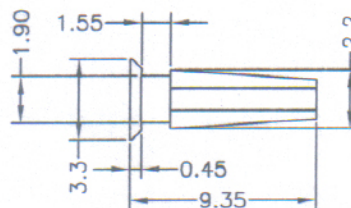

inches
mm

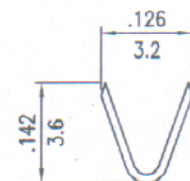

A-A SECTION

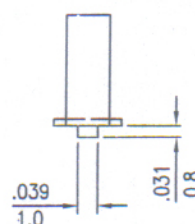
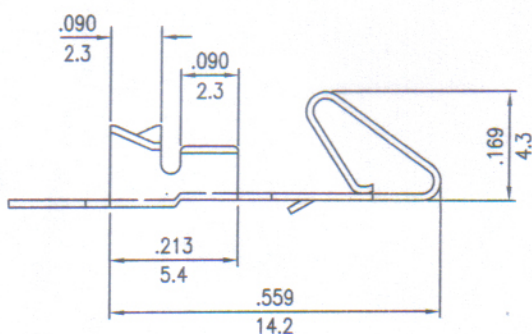

B-B SECTION